

OUSILONG

Screen
Ceiling Series

041/

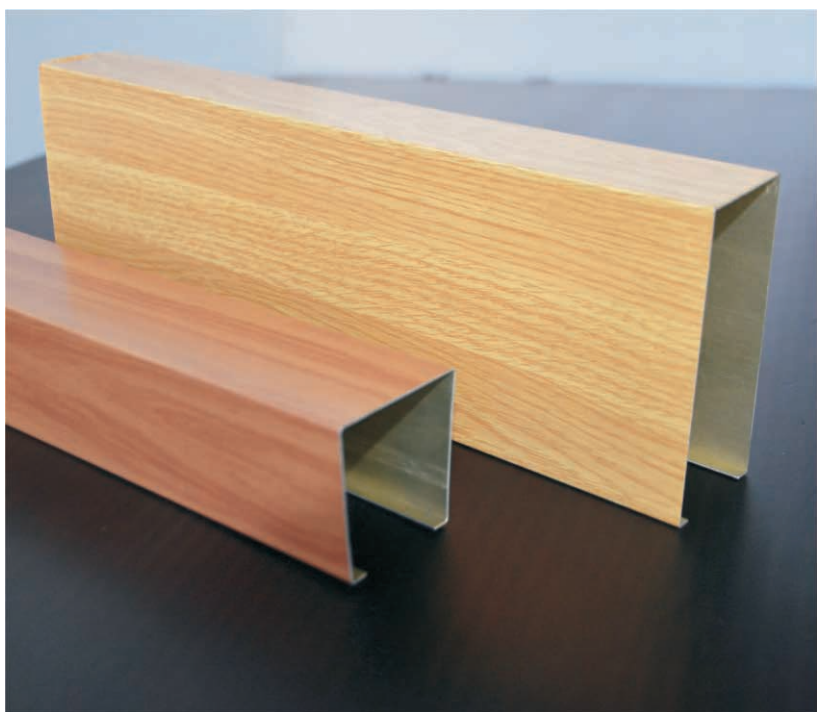

U-aluminum Screen Ceiling

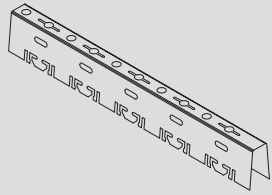

U-aluminum Screen Ceiling Carrier
 Material: Steel
 Surface finish: Galvanization
 Height: 25mm
 Standard Thickness: 0.7mm



Carrier hanger
 No.: PBL01J
 Materials: Steel
 Surface finish: Galvanization
 Standard thickness: 1.0mm

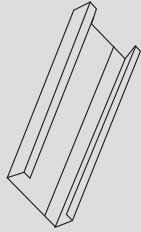

38# Main runner
 Material: Steel
 Surface finish: Galvanization
 Size: 38x12mm
 Standard Thickness: 1.2mm

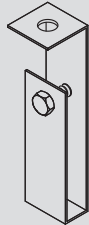

Main runner hanger
 No.: PGG01J
 Materials: Steel
 Surface finish: Galvanization
 Height: 95/105mm
 Standard thickness: 0.6mm

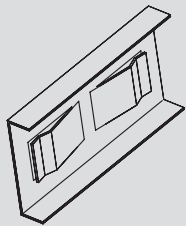

Main runner connector
 No.: PGG01L
 Materials: Steel
 Surface finish: Galvanization
 Height: 41/53mm
 Standard thickness: 0.6mm

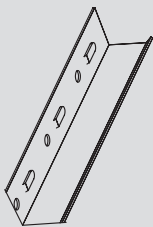

L25 wall angle
 Materials: Grade AA aluminum alloy
 Surface finish: Powder coating
 Specification: 25mm x 25mm
 Length: 3000mm
 Standard thickness: 0.6mm

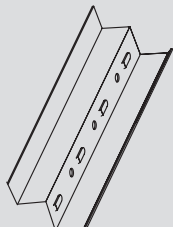

W25 wall angle
 Materials: Grade AA aluminum alloy
 Surface finish: Powder coating
 Specification: 24x11x1x24mm
 Length: 3000mm
 Standard thickness: 0.8mm

Installation Diagram

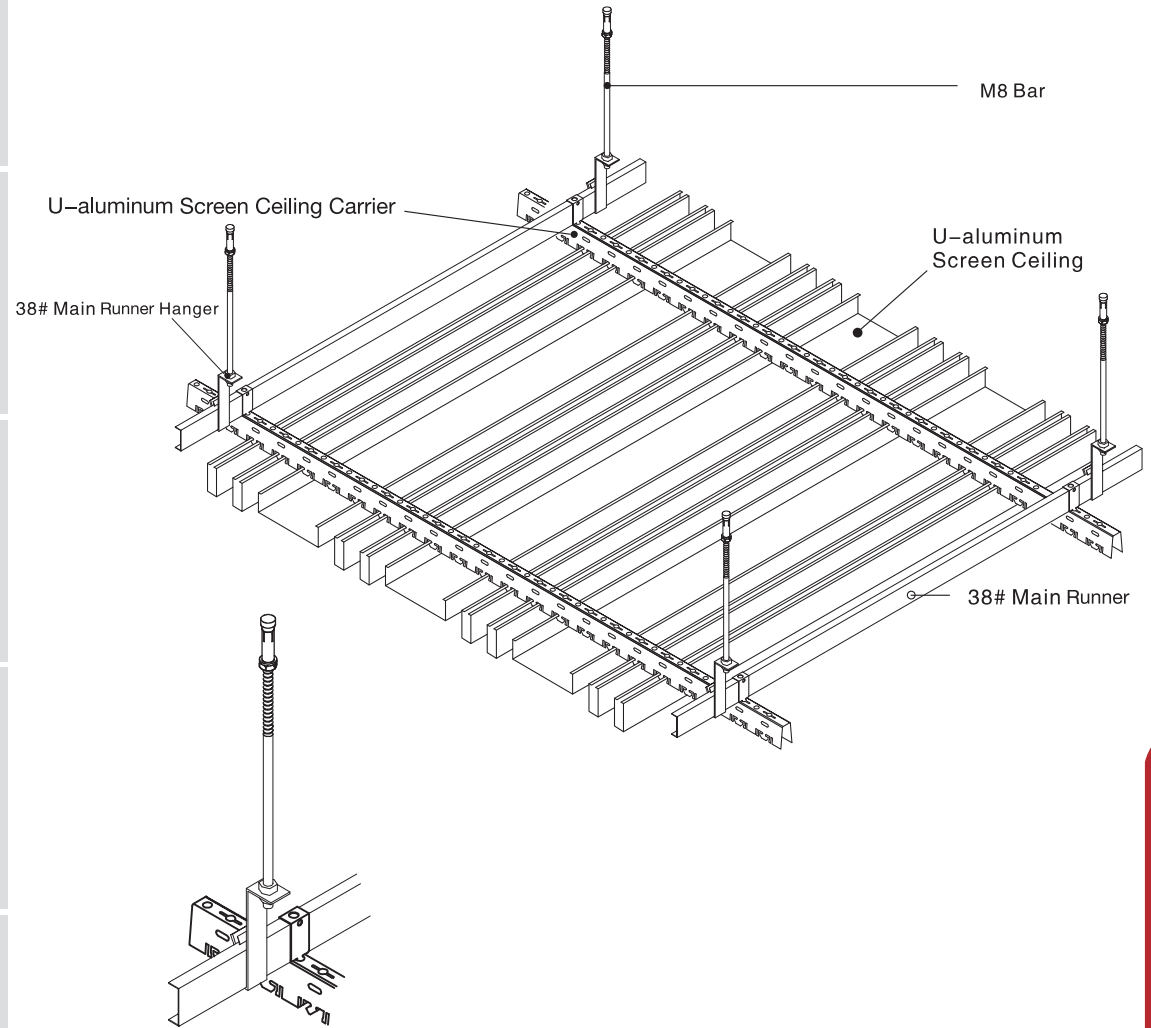

Material: Aluminum Alloy
 Surface Finish: Akzo Nobel Electrostatic
 Powder Coated
 Standard Thickness: 0.5-1.2mm

U-aluminum Profile Screen Ceiling Unit: mm

Width	Height	Thickness	illustration
25	20-100	0.5-1.0	
30	30-100	0.6-1.0	
50	50-150	0.6-1.5	
75	75-150	0.7-1.5	
100	100-200	0.8-2.0	
150	150-250	0.8-2.0	

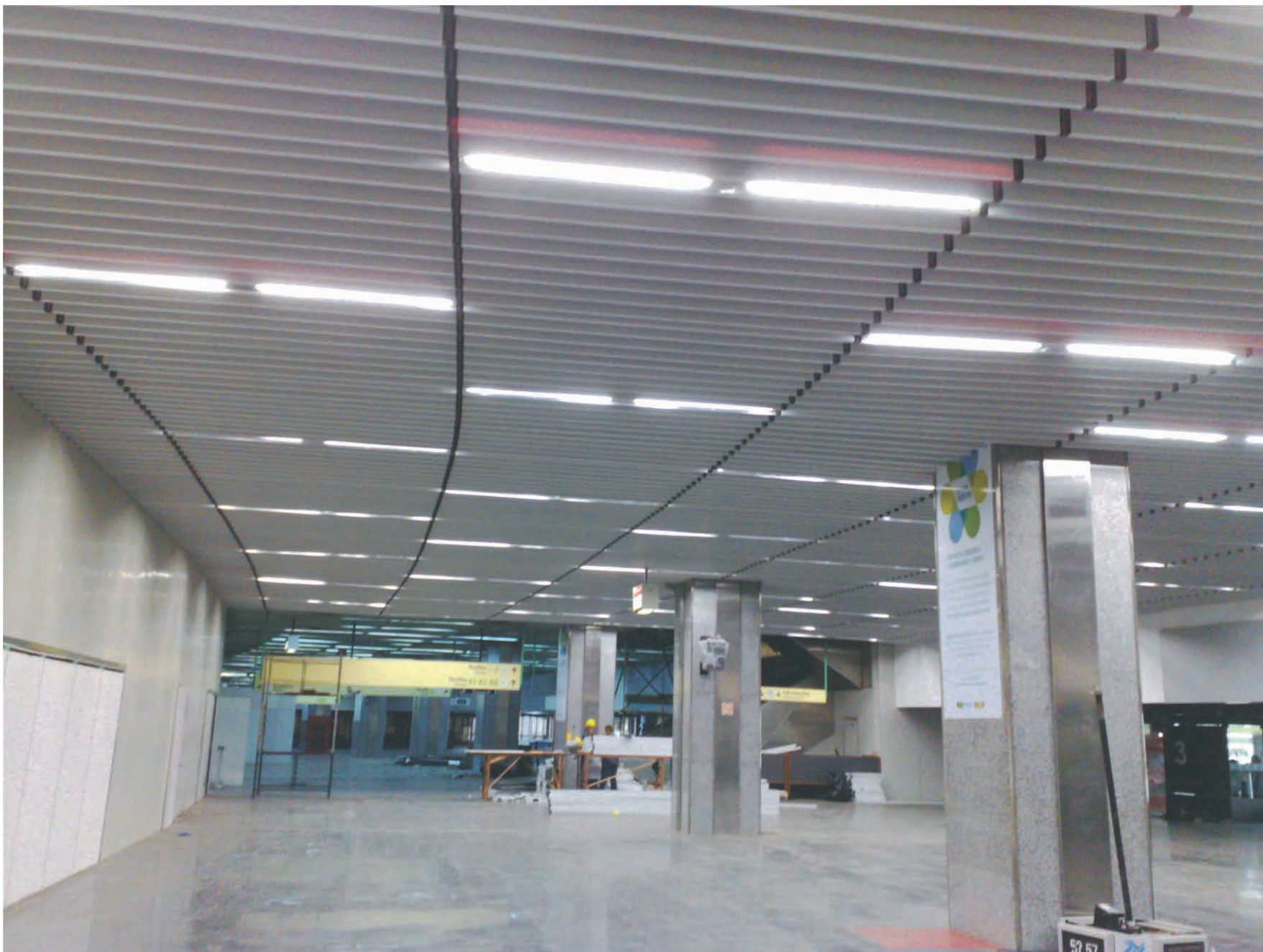

▲ **Project:** Guarulhos International Airport, Sao Paulo, Brazil
Product: U-aluminum Screen Ceiling



